

标准型齿轮无刷减速电机 BLDC Spur Gear Motor

80CJB600K/80BL85

80CJB标准型减速器, 允许转矩范围: 2N.m~60N.m
80CJB Standard Gearbox,
Permissible Load Range: 2N.m~60N.m

外形和安装尺寸

Dimensions

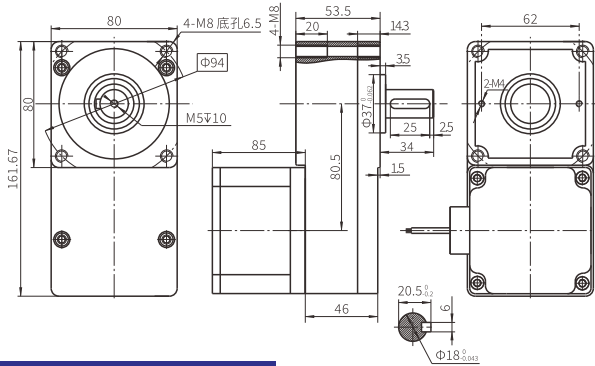

无刷电动机主要技术参数

Brushless Motor Technical Data

电机型号 Type	极数 Number of poles	相数 Number of phase	额定电压 Rated Voltage VDC	空载转速 No-load Speed r/min	额定转速 Rated Speed r/min	额定转矩 Rated Torque N.m	额定功率 Rated Power W	额定电流 Rated Current A	峰值转矩 Peak Torque N.m	峰值电流 Peak Current A	电阻 Line to line resistance ohms	电感 Line to line inductance mH
80BL85-2440	10	3	24	4000	3000	0.32	100	5.21	0.64	10.42	0.255	0.69
80BL85-2449	10	3	24	4900	4000	0.36	150	7.81	0.72	15.63	0.139	0.39

无刷行星齿轮减速电机主要技术参数

Brushless Gear Motor Technical Data

配置80BL85-2440无刷直流电机(80BL85-2440 BLDC Motor)

减速比 Reduction ratio	5	10	15	20	30	50	100	150	200
减速级数 Number of gear trains	1	1	1	1	1	2	2	2	2
减速器长度(L) Length mm	53.5	53.5	53.5	53.5	53.5	53.5	53.5	53.5	53.5
空载速度 No-load speed r/min	800	400	267	200	133	80	40	27	20
额定转速 Rated speed r/min	600	300	200	150	100	60	30	20	15
额定转矩 Rated torque N.m	1.4	2.9	4.3	5.7	8.6	12.9	25.8	38.7	51.6
最大瞬间允许负载 Max. permissible load in a short time N.m	5	10	15	25	25	40	60	100	120

配置80BL85-2449无刷直流电机(80BL85-2449 BLDC Motor)

减速比 Reduction ratio	5	10	15	20	30	50	100	150	200
减速级数 Number of gear trains	1	1	1	1	1	2	2	2	2
减速器长度(L) Length mm	53.5	53.5	53.5	53.5	53.5	53.5	53.5	53.5	53.5
空载速度 No-load speed r/min	980	490	327	245	163	98	49	33	25
额定转速 Rated speed r/min	800	400	267	200	133	80	40	27	20
额定转矩 Rated torque N.m	1.6	3.2	4.8	6.4	9.7	14.5	29.0	43.5	58.0
最大瞬间允许负载 Max. permissible load in a short time N.m	5	10	15	25	25	40	60	100	120

接线方式

Wire Diagram

U	V	W	Vcc	Ha	Hb	Hc	GND
电机 Motor			霍尔 Hall				